

Basic

MOVING UPWARDS



 Alla fine degli anni '70 **Manzelli**, realtà stimata nel settore delle forniture industriali per il marmo già dagli anni '50, diede inizio alla produzione delle prime ventose per il sollevamento ad aria compressa.

Oggi, grazie all'esperienza acquisita e interpretando le esigenze dei clienti, **Manzelli** è riconosciuta come azienda leader nella progettazione di apparecchiature per il sollevamento. Il brand **Manzelli** viene infatti apprezzato sui mercati internazionali per il suo inconfondibile *Made in Italy* e per l'accattivante *design*, che lo rendono il più apprezzato dagli operatori di settore.

L'offerta di apparecchiature **Manzelli** abbraccia i più svariati settori: marmo, vetro, metallo, lamiera, legno e packaging.

Negli ultimi anni di crescita aziendale, grazie alla maggiore presenza sui mercati internazionali e stimolati ad arricchire la nostra offerta, **Liftstyle** ha introdotto due nuove linee di prodotto:

Atmosphere - Air purification systems

Terra - Water purification systems

La nostra filosofia aziendale stimola la ricerca a elevare la qualità del prodotto, rafforzando la nostra *mission* nel perseguire valide soluzioni tecniche, rivolte alla sicurezza delle persone che ci scelgono come loro partner.

 Esteemed reality in the marble industry from the '50, **Manzelli** started the production of air powered vacuum lifters at the end of the '70.

Thanks to the long experience and the requests received from key clients through the years, **Manzelli** is a recognized leading brand in the manufacture of lifting equipment. The brand is appreciated worldwide for its unique *Made in Italy* style and its attractive *design*, which make the **Manzellis** the most appreciated lifters in the stone sector.

The product range includes many industries: stone, glass, metal, wood and packaging.

During the years, **Liftstyle** has become even more competitive on the international markets. This credit encouraged us to increase our offer; therefore we introduced two new product lines:

Atmosphere - Air purification systems

Terra - Water purification systems

Our corporate philosophy drives us to constant research for the improvement of our quality, and it fortifies our *mission* of enhancing our technical solutions, aimed at the safety of those who choose Liftstyle as their partner.

**QUALITY, SAFETY, PERFORMANCE:
MINIMUM EFFORT FOR MAXIMUM RESULTS**



Our Basic Line lifters for your great deals.

A precise machine for an accurate work.

A reliable device for a safe bet.

- Funzionante ad aria compressa con eiettore in alluminio e silenziatore in nylon
- Pressione d'esercizio per creazione vuoto 6 bar
- Consumo d'aria 120 l/min
- Portata uguale in posizione orizzontale e verticale
- Struttura in acciaio saldata con certificazione EN ISO 9606 - 1:2013
- Piastre e contropiastre in acciaio galvanizzato
- Supporti piastra con attacco rapido
- Attacco e stacco delle piastre per mezzo di valvola a corsoio in pvc bianco con blocco in posizione di presa
- Vuotometro in metallo nero; la scala colorata facilita il controllo del grado di vuoto in posizione di presa
- Serbatoio di riserva vuoto in acciaio verniciato
- **Ribaltamento manuale o pneumatico da 0° a 90°**
- Allarme elettronico acustico e luminoso autonomo, completo di caricabatteria (lampeggia e suona se il grado di vuoto non è sufficiente per il sollevamento)

- *Powered by compressed air with aluminium ejector and nylon silencer*
- *Operating pressure for vacuum creation 6 bar*
- *Air consumption 120 l/min*
- *Same capacity in horizontal and vertical position*
- *Steel structure, welded and certified EN ISO 9606 - 1:2013*
- *Suction plates and backing plates made of galvanized steel*
- *Supports with rapid attack*
- *Connection and disconnection of the plates by means of slider valve made of white pvc; it locks when in connect mode*
- *Vacuum gauge made of black metal; the coloured scale facilitates the control of the vacuum level when in connect mode*
- *Vacuum reserve tank made of painted steel*
- ***Manual or pneumatic tilt from 0° to 90°***
- *Electronic self-governing luminous/acoustic alarm system, complete with battery charger (it flashes and rings if the vacuum level is not sufficient for the lifting process)*



Basic

MOVING UPWARDS

BAS 1 HP

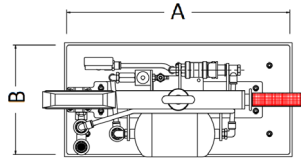
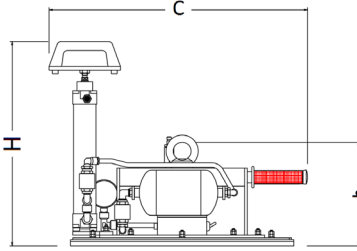

MODELLO MODEL	PORTATA (KG) CAPACITY	PIASTRE PLATES	A mm	B mm	C mm	H mm	h mm
BAS 1/300 HP	300	1	500	250	580	485	260
BAS 1/400 HP	400	1	650	250	580	485	260
BAS 1/500 HP	500	1	500	350	580	485	260
BAS 1/600 HP	600	1	650	350	580	485	260

Funzionamento ad ARIA COMPRESSA o POMPA A MANO
Portata da 300 a 600 Kg / Fissa in orizzontale
Powered by COMPRESSED AIR or HAND PUMP
Capacity from 300 to 600 Kg / Fixed in horizontal

BAS 1

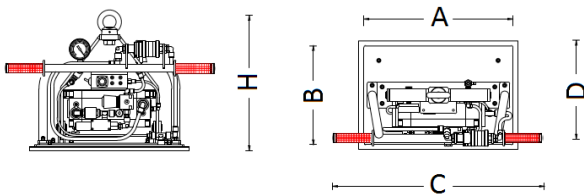
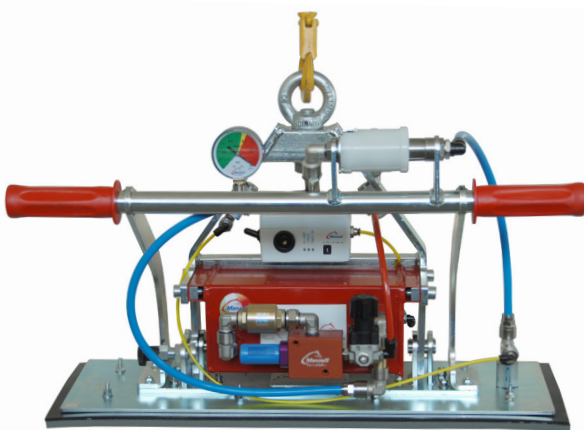

Portata da 125 a 1000 Kg / Ribaltamento MANUALE da 0° a 90°
Capacity from 125 to 1000 Kg / MANUAL tilt from 0° to 90°

MODELLO MODEL	PORTATA (KG) CAPACITY	PIASTRE PLATES	A mm	B mm	C mm	D mm	H mm
BAS 1/125	125	1	450	200	630	245	400
BAS 1/125	125	1	550	150	450	340	570
BAS 1/200	200	1	600	200	630	245	400
BAS 1/200	200	1	700	160	740	225	420
BAS 1/250	250	1	600	250	630	270	400
BAS 1/250	250	1	450	300	630	295	400
BAS 1/300	300	1	600	300	630	295	400
BAS 1/300	300	1	800	200	740	245	420
BAS 1/500	500	1	600	400	740	345	420
BAS 1/500	500	1	800	300	740	295	420
BAS 1/800	800	1	900	450	510	530	600
BAS 1/1000	1000	1	900	500	510	555	600

BAS 1PN

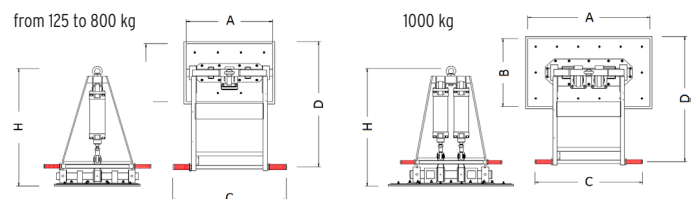
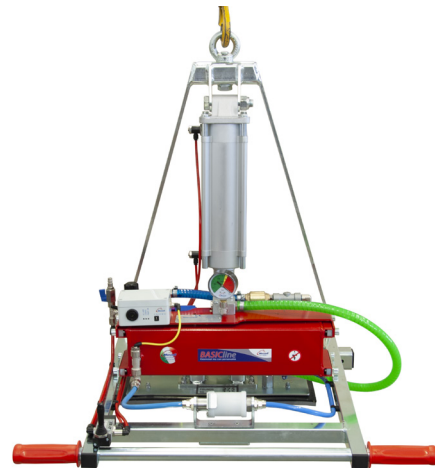

Portata da 125 a 1000 Kg / Ribaltamento PNEUMATICO da 0° a 90°
Capacity from 125 to 1000 Kg / PNEUMATIC tilt from 0° to 90°

MODELLO MODEL	PORTATA (KG) CAPACITY	PIASTRE PLATES	A mm	B mm	C mm	D mm	H mm
BAS 1PN/125	125	1	450	200	780	765	865
BAS 1PN/125	125	1	550	150	780	720	865
BAS 1PN/200	200	1	600	200	780	765	865
BAS 1PN/200	200	1	700	160	780	735	880
BAS 1PN/250	250	1	450	300	780	815	865
BAS 1PN/250	250	1	600	250	780	790	865
BAS 1PN/300	300	1	600	300	780	815	865
BAS 1PN/300	300	1	800	200	780	765	880
BAS 1PN/500	500	1	600	400	780	865	865
BAS 1PN/500	500	1	800	300	780	815	865
BAS 1PN/800	800	1	900	450	780	895	865
BAS 1PN/1000	1000	1	900	500	780	920	885

BAS 2

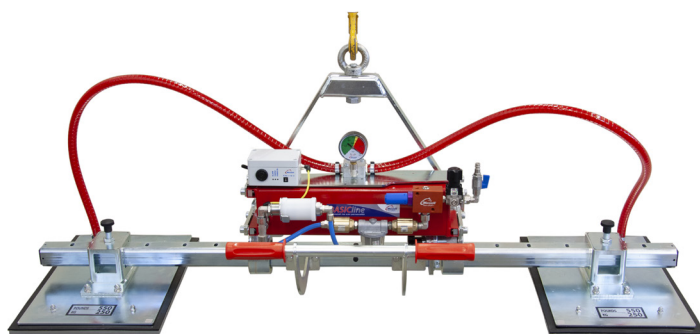
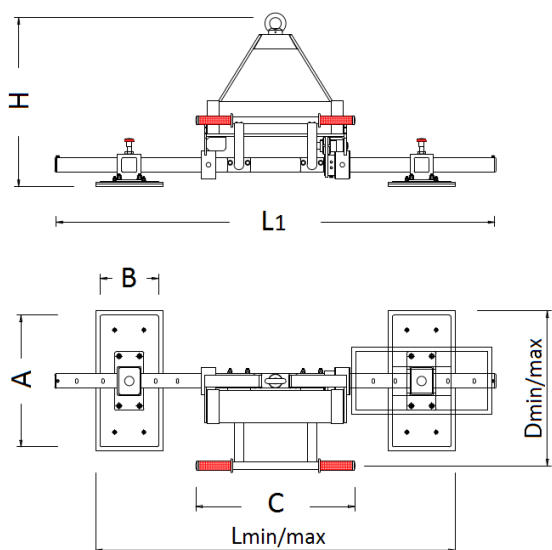

Portata da 250 a 1000 Kg / Ribaltamento MANUALE da 0° a 90°
Capacity from 250 to 1000 Kg / MANUAL tilt from 0° to 90°

MODELLO MODEL	PORTATA (KG) CAPACITY	PIASTRE PLATES	A mm	B mm	C mm	D min mm	D max mm	L1 mm	L min mm	L max mm	H mm
BAS 2/250	250	2	450	200	510	405	530	1500	900	1840	575
BAS 2/500	500	2	450	300	510	455	530	1500	1000	1840	575
BAS 2/1000	1000	2	600	400	510	510	610	1500	1140	2005	680

BAS 2PN

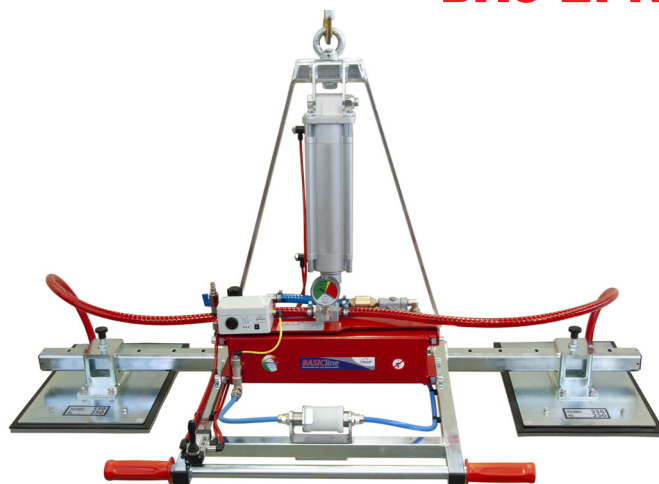
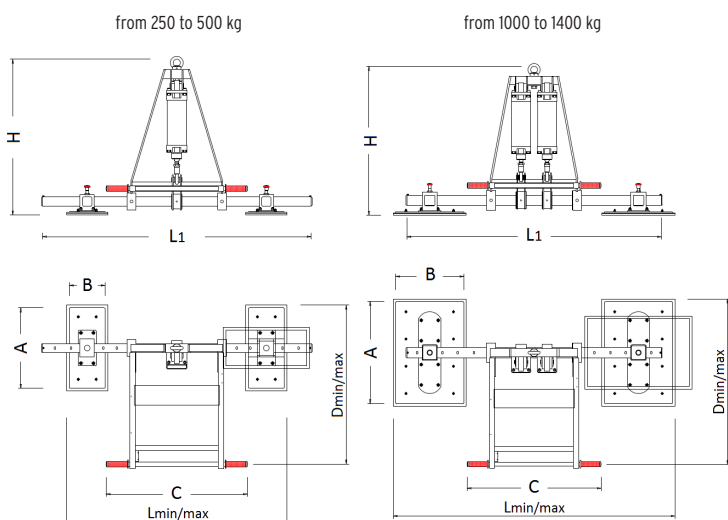

Portata da 250 a 1400 Kg / Ribaltamento PNEUMATICO da 0° a 90°
Capacity from 250 to 1400 Kg / PNEUMATIC tilt from 0° to 90°

MODELLO MODEL	PORTATA (KG) CAPACITY	PIASTRE PLATES	A mm	B mm	C mm	D min mm	D max mm	L1 mm	L min mm	L max mm	H mm
BAS 2PN/250	250	2	450	200	780	765	890	1500	900	1840	865
BAS 2PN/500	500	2	450	300	780	815	890	1500	1000	1840	865
BAS 2PN/1000	1000	2	600	400	780	870	970	1500	1140	2005	870
BAS 2PN/1400	1400	2	800	400	780	895	1095	1500	1140	2205	1045

BAS 3

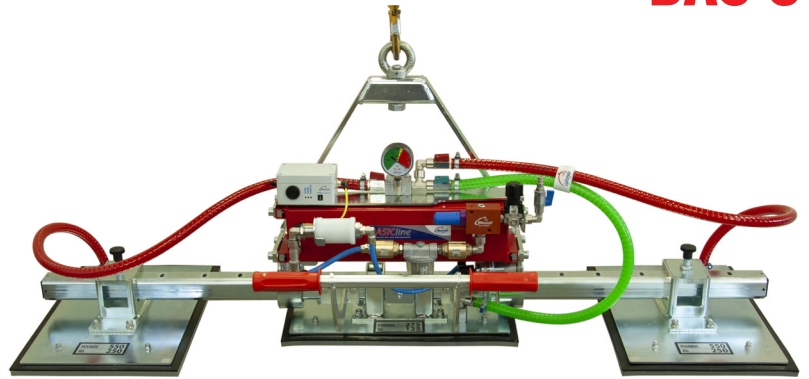
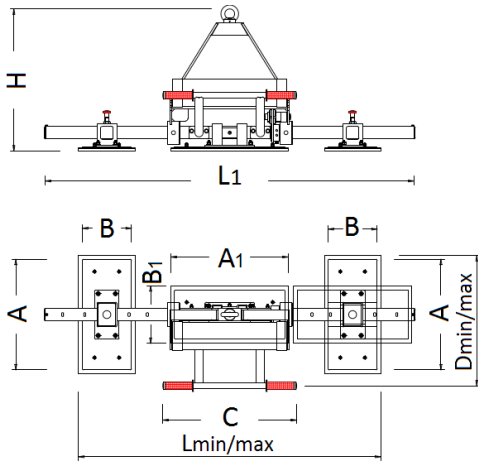

Portata da 375 a 1500 Kg / Ribaltamento MANUALE da 0° a 90°
Capacity from 375 to 1500 Kg / MANUAL tilt from 0° to 90°

MODELLO MODEL	PORTATA (KG) CAPACITY	PIASTRE PLATES	A mm	B mm	A1 mm	B1 mm	C mm	D min mm	D max mm	L1 mm	L min mm	L max mm	H mm
BAS 3/375	375	3	450	200	450	200	510	405	530	1500	1050	1840	575
BAS 3/625	625	3	450	300	450	200	510	455	530	1500	1150	1840	575
BAS 3/750	750	3	450	300	450	300	510	455	530	1500	1150	1840	575
BAS 3/1250	1250	3	600	400	600	250	510	510	610	1500	1510	2005	690
BAS 3/1500	1500	3	600	400	600	400	510	510	610	1500	1510	2005	690

from 375 to 750 kg

from 1000 to 1500 kg

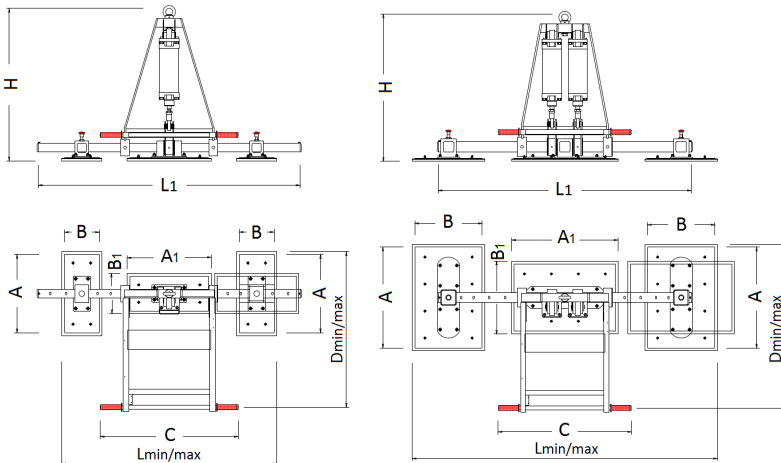

BAS 3PN

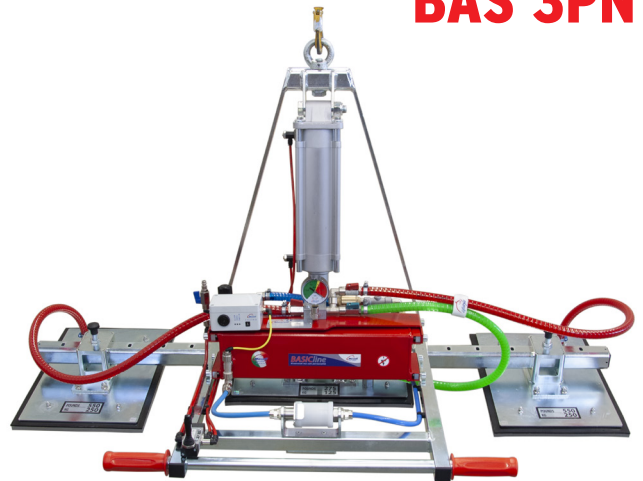

Portata da 375 a 1500 Kg / Ribaltamento PNEUMATICO da 0° a 90°
Capacity from 375 to 1500 Kg / PNEUMATIC tilt from 0° to 90°

MODELLO MODEL	PORTATA (KG) CAPACITY	PIASTRE PLATES	A mm	B mm	A1 mm	B1 mm	C mm	D min mm	D max mm	L1 mm	L min mm	L max mm	H mm
BAS 3PN/375	375	3	450	200	450	200	780	765	890	1500	1050	1840	865
BAS 3PN/625	625	3	450	300	450	200	780	815	890	1500	1150	1840	865
BAS 3PN/750	750	3	450	300	450	300	780	815	890	1500	1150	1840	895
BAS 3PN/1000	1000	3	600	400	600	250	780	870	970	1500	1510	2005	870
BAS 3PN/1250	1250	3	600	400	600	250	780	895	995	1500	1510	2005	1045
BAS 3PN/1500	1500	3	600	400	600	400	780	895	995	1500	1510	2005	1045

BAS 4

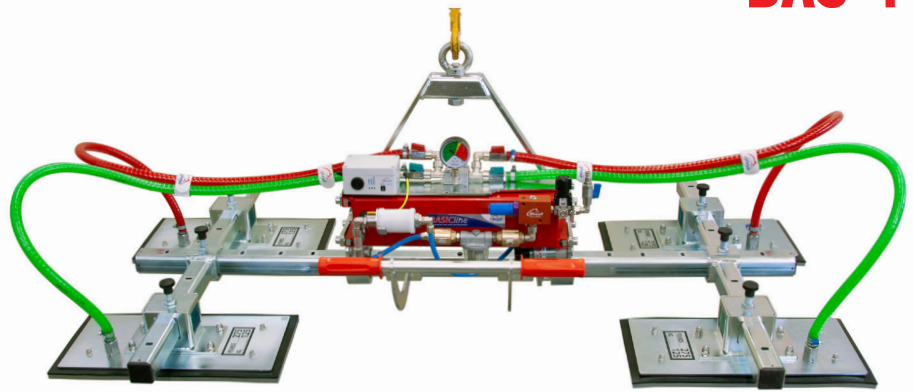
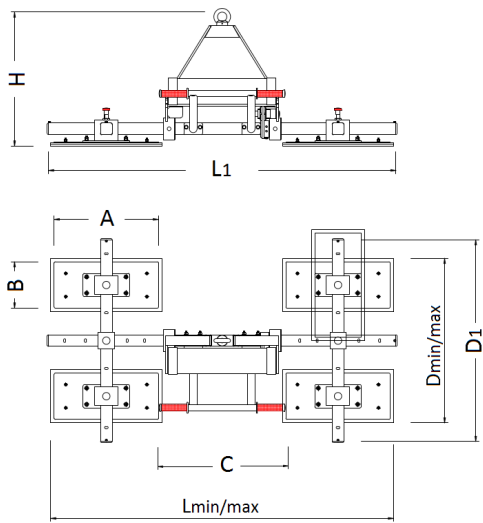

Portata da 500 a 2000 Kg / Ribaltamento MANUALE da 0° a 90°
Capacity from 500 to 2000 Kg / MANUAL tilt from 0° to 90°

MODELLO MODEL	PORTATA (KG) CAPACITY	PIASTRE PLATES	A mm	B mm	C mm	D1 mm	D min mm	D max mm	L1 mm	L min mm	L max mm	H mm
BAS 4/500	500	4	450	200	510	870	470	1230	1500	900	1840	575
BAS 4/1000	1000	4	450	300	510	880	670	1240	1500	1040	1855	670
BAS 4/1500	1500	4	600	300	510	880	670	1390	1500	1040	2005	680
BAS 4/2000	2000	4	600	400	510	810	870	1320	1500	1200	2020	760

BAS 4PN

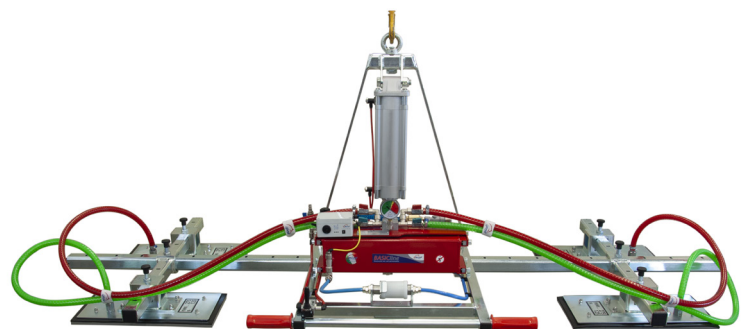
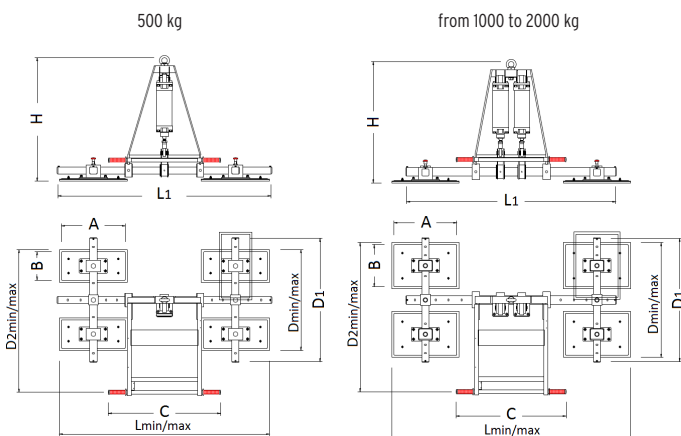

Portata da 500 a 2000 Kg / Ribaltamento PNEUMATICO da 0° a 90°
Capacity from 500 to 2000 Kg / PNEUMATIC tilt from 0° to 90°

MODELLO MODEL	PORTATA (KG) CAPACITY	PIASTRE PLATES	A mm	B mm	C mm	D1 mm	D min mm	D max mm	D2 min mm	D2 max mm	L min mm	L max (L1=1500) mm	L max (L1=2400) mm	H mm
BAS 4PN/500 L1=1500/2400	500	4	450	200	780	870	470	1230	885	1265	900	1840	2310	866
BAS 4PN/500 KTV L1=2400	500	4	550	150	780	870	400	1310	830	1305	830	-	2390	865
BAS 4PN/1000 L1=1500/2400	1000	4	450	300	780	880	670	1240	990	1275	1110	1855	2220	860
BAS 4PN/1500	1500	4	600	300	780	880	670	1390	1015	1375	1040	2005	-	1030
BAS 4PN/2000	2000	4	600	400	780	810	870	1320	1195	1420	1230	2050	-	1270

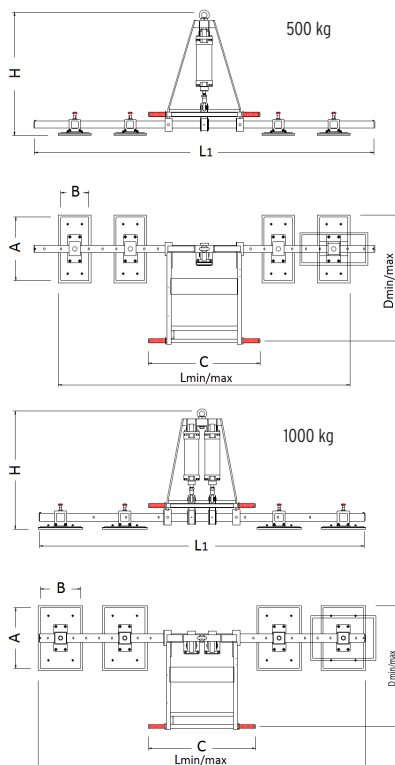

BAS 4PN KTL

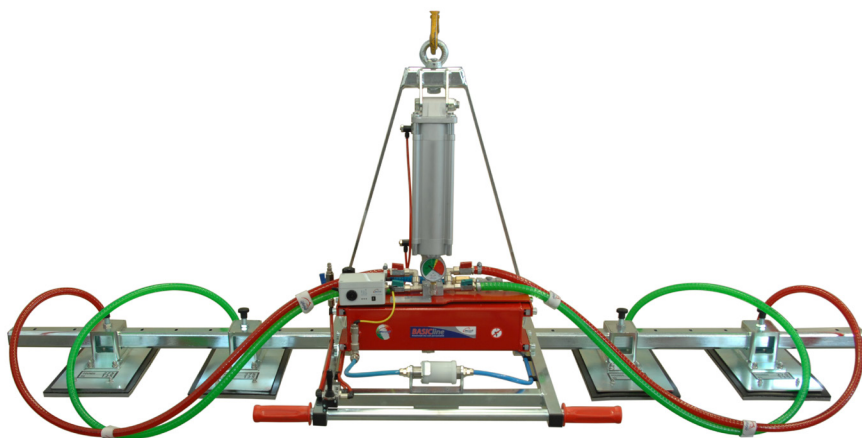

Piani cucina IN LINEA

Portata da 500 a 1000 Kg / Ribaltamento PNEUMATICO da 0° a 90°

Kitchen tops IN LINE

Capacity from 500 to 1000 Kg / PNEUMATIC tilt from 0° to 90°

MODELLO MODEL	PORTATA (KG) CAPACITY	PIASTRE PLATES	A mm	B mm	C mm	D min mm	D max mm	L1 mm	L min mm	L max mm	H mm
BAS 4PN/500 KTL	500	4	450	200	780	765	890	2400	1475	2740	865
BAS 4PN/500 KTL	500	4	550	150	780	740	930	2400	1205	2820	865
BAS 4PN/1000 KTL	1000	4	450	300	780	820	895	2400	1850	2755	870

BAS 5

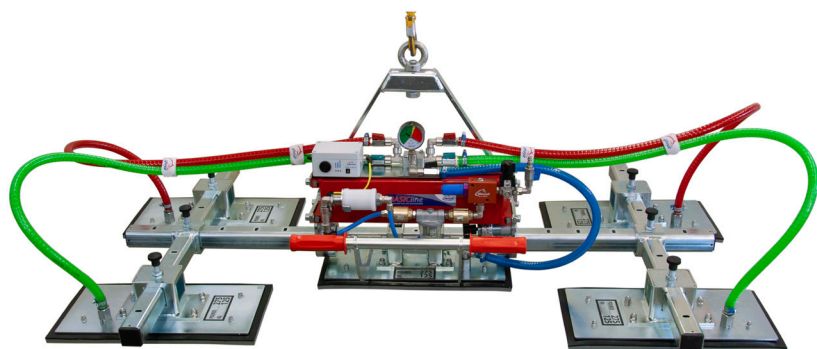
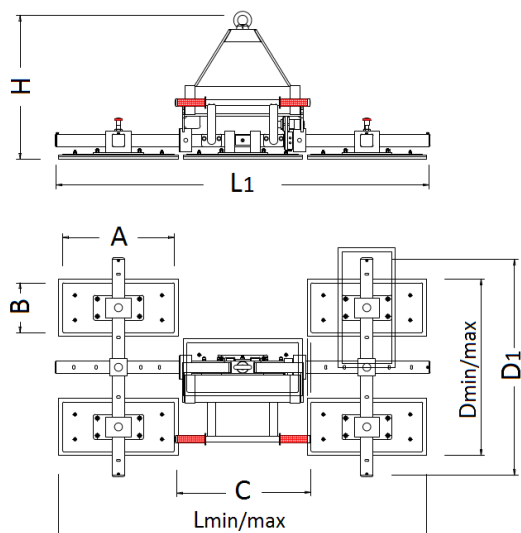

Portata da 625 a 1500 Kg / Ribaltamento MANUALE da 0° a 90°

Capacity from 625 to 1500 Kg / MANUAL tilt from 0° to 90°

MODELLO MODEL	PORTATA (KG) CAPACITY	PIASTRE PLATES	A mm	B mm	C mm	D1 mm	D min mm	D max mm	L1 mm	L min mm	L max mm	H mm
BAS 5/625	625	5	450	200	510	870	470	1230	1500	900**	1840	575
BAS 5/1000	1000	5	450	300	510	880	670	1240	1500	1190*	1855	680
BAS 5/1500	1500	5	600	300	510	880	670	1390	1500	1340*	2005	690

* PIASTRE ORIZZONTALI -> ESTENSIONE MAX SU SBRACCI / HORIZONTAL PLATES -> MAX EXTENSION ON THE ARMS

** PIASTRE VERTICALI -> ESTENSIONE MAX SU SBRACCI / VERTICAL PLATES -> MAX EXTENSION ON THE ARMS

BAS 5PN

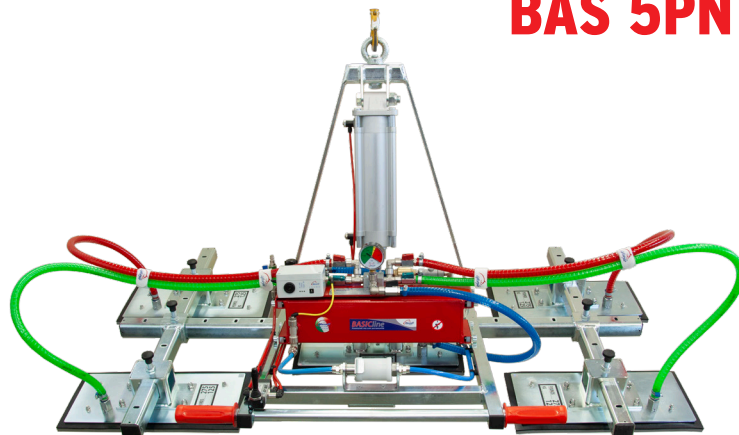
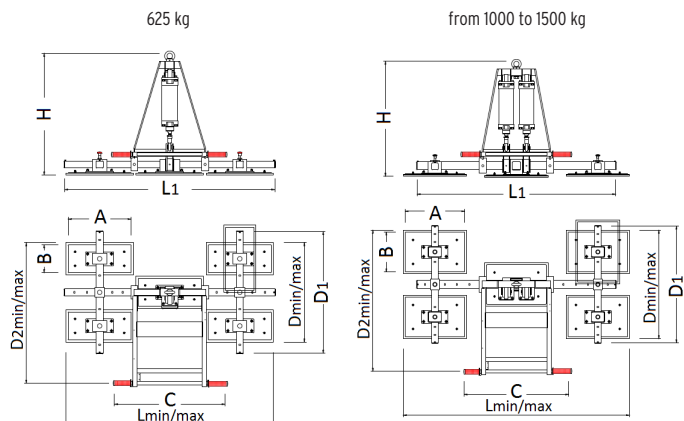

Portata da 625 a 1500 Kg / Ribaltamento PNEUMATICO da 0° a 90°
Capacity from 625 to 1500 Kg / PNEUMATIC tilt from 0° to 90°

MODELLO MODEL	PORTATA (KG) CAPACITY	PIASTRE PLATES	A mm	B mm	C mm	D1 mm	D min mm	D max mm	D2 min mm	D2 max mm	L min mm	L max (L1=1500) mm	L max (L1=2400) mm	H mm
BAS 5PN/625 L1=1500/2400	625	5	450	200	780	870	470	1230	885	1265	900**	1840	2310	865
BAS 5PN/625 KTV L1=2400	625	5	550	150	780	870	400	1310	850	1305	830	-	2390	865
BAS 5PN/1000 L1=1500/2400	1000	5	450	300	780	880	670	1240	990	1275	1260*	1855	2220	870
BAS 5PN/1500	1500	5	600	300	780	880	670	1400	1015	1380	1340*	2005	-	1040

* PIASTRE ORIZZONTALI -> ESTENSIONE MAX SU SBRACCI / HORIZONTAL PLATES -> MAX EXTENSION ON THE ARMS

** PIASTRE VERTICALI -> ESTENSIONE MAX SU SBRACCI / VERTICAL PLATES -> MAX EXTENSION ON THE ARMS

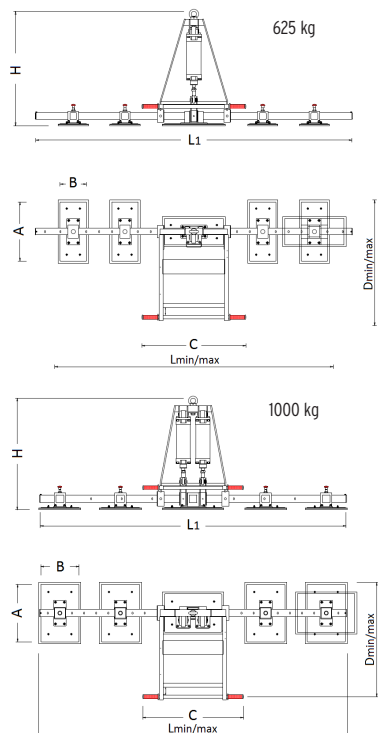

BAS 5PN KTL

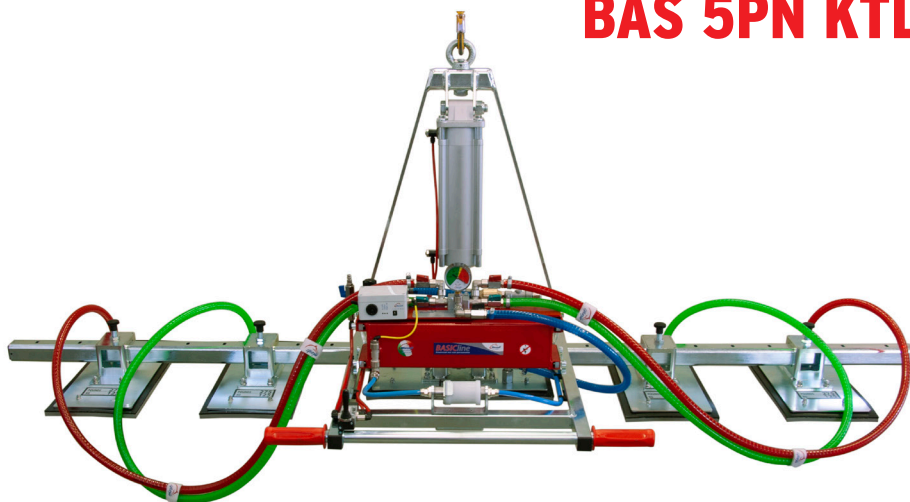

Piani cucina IN LINEA

Portata da 625 a 1000 Kg / Ribaltamento PNEUMATICO da 0° a 90°

Kitchen tops IN LINE

Capacity from 625 to 1000 Kg / PNEUMATIC tilt from 0° to 90°

MODELLO MODEL	PORTATA (KG) CAPACITY	PIASTRE PLATES	A mm	B mm	C mm	D min mm	D max mm	L1 mm	L min mm	L max mm	H mm
BAS 5PN/625 KTL	625	5	450	200	780	765	890	2400	1670	2740	865
BAS 5PN/625 KTL	625	5	550	150	780	740	930	2400	1402	2820	865
BAS 5PN/1000 KTL	1000	5	450	300	780	820	895	2400	2040	2755	870

SPECIAL SOLUTIONS

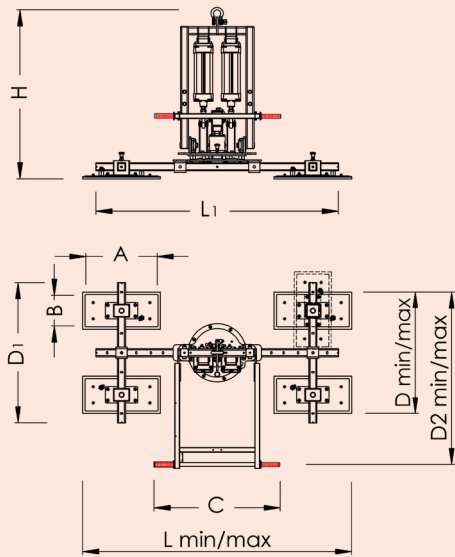

BAS 4PN-G

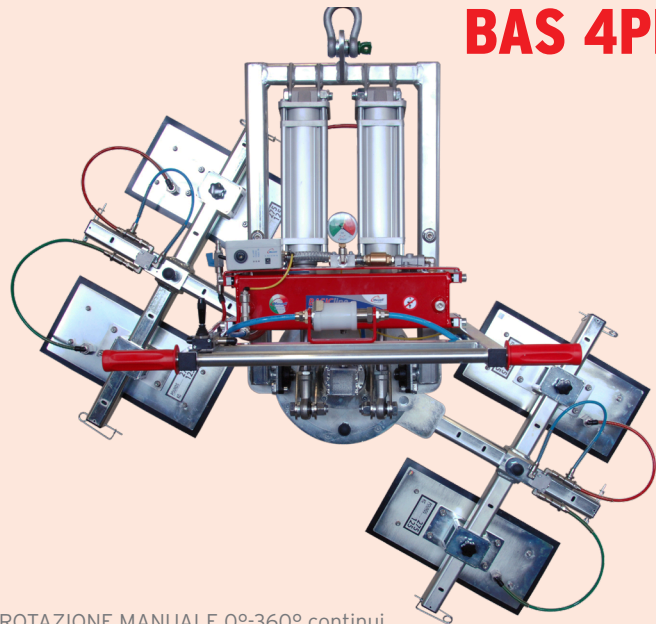

Portata 500 Kg. RIBALTAMENTO PNEUMATICO da 0° a 90° / ROTAZIONE MANUALE 0°-360° continui
Capacity 500 Kg. PNEUMATIC TILT from 0° to 90° / MANUAL continuous ROTATION 0°-360°

MODELLO MODEL	PORTATA (KG) CAPACITY	PIASTRE PLATES	A mm	B mm	C mm	D1 mm	D min mm	D max mm	D2 min mm	D2 max mm	L1 mm	L min mm	L max mm	H mm
BAS 4PN-G/500	500	4	450	200	780	870	470	1230	925	1305	1500	900	1840	1045
BAS 4PN-G/500 KTV	500	4	450	200	780	870	470	1230	885	1265	2400	900	2310	1045

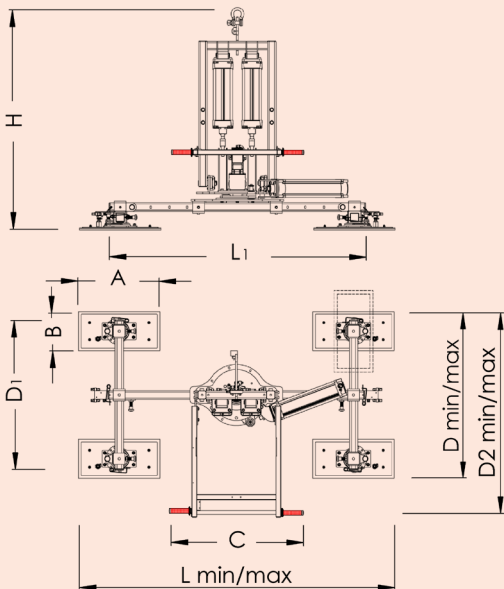

BAS 4PN-GPN

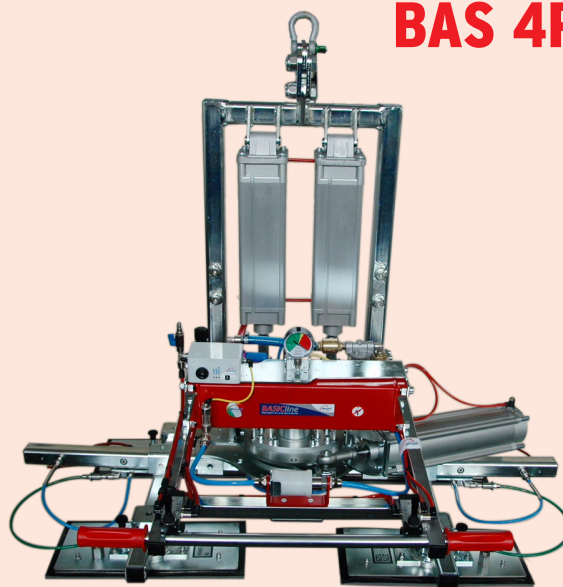

Portata 500 Kg. Ribaltamento PNEUMATICO da 0° a 90° / ROTAZIONE PNEUMATICA 0°-180°
Capacity 500 Kg. PNEUMATIC TILT from 0° to 90° / PNEUMATIC ROTATION 0°-180°

MODELLO MODEL	PORTATA (KG) CAPACITY	PIASTRE PLATES	A mm	B mm	C mm	D1 mm	D min mm	D max mm	D2 min mm	D2 max mm	L1 mm	L min mm	L max mm	H mm
BAS 4PN-GPN/500	500	4	450	200	780	870	470	1230	925	1305	1500	960	1860	1295

ACCESSORI / ACCESSORIES



ESPOSITORE CON RUOTE GIREVOLI
DISPLAY STAND WITH SWIVEL CASTERS



SOSTEGNO PORTA PULSANTIERA
PUSH BUTTON PENDANT HOLDER



SUPPORTI
GIREVOLI 0-90°
ROTATING
SUPPORTS 0-90°



KIT PIASTRINE SALVA PIANO CUCINA
SAVE KITCHEN TOP LITTLE PLATES KIT

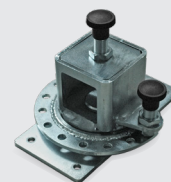

SUPPORTI GIREVOLI
MULTIPOSIZIONE 0-180°
MULTI-POSITION ROTATING
SUPPORTS 0-180°

**LIFTSTYLE s.r.l.**

Via Enrico Fermi, 26
37026 Settimo di Pescantina
VERONA - Italia
P.iva 03482320235
tel. 0039 045 6450860
fax 0039 045 6450297
www.manzelli.net
e-mail: info@manzelli.it

